

Face Recognition Terminal

User's Guide

**THIS EQUIPMENT COMPLIES WITH FCC REQUIREMENTS
PURSUANT OF PART-15**

This device complies with Part 15 of the FCC Rules. Operation is subject to the following two conditions: (1) this device may not cause harmful interference, and (2) this device must accept any interference received, including interference that may cause undesired operation.

WARNING: Changes or modifications to this product not expressly approved by the party responsible for compliance could void the user's authority to operate this equipment.

NOTE: This equipment has been tested and found to comply with the limits, pursuant to Part 15 of the FCC Rules. These limits are designed to provide reasonable protection against harmful interference in a business installation. This equipment generates, uses, and can radiate radio frequency energy and, if not installed and used in accordance with the instructions, may cause harmful interference to radio communications. However, there is no guarantee that interference will not occur in a particular installation. If this equipment does cause harmful interference to radio or television reception, which can be determined by turning the equipment off and on, the user is encouraged to try to correct the interference by one or more of the following measures:

- Reorient or relocate the receiving antenna.
- Increase the separation between the equipment and receiver.
- Connect the equipment into an outlet on a circuit different from that to which the receiver is connected.
- Consult the dealer or an experienced radio TV technician for help.

**This Class A digital apparatus complies with Canadian ICES-003.
Cet appareil numérique de la classe A est conforme a la norme NMB-003 du
Canada.**

Lathem Time Corporation
200 Selig Drive, SW,
Atlanta, GA 30336
404-691-0405

www.lathem.com

Copyright © 2010 Lathem Time Corporation. All rights reserved.

Revised 08-17-2011

Document number: USG0098 Rev. C

One-Year Limited Warranty

Lathem warrants the hardware products described in this guide against defects in material and workmanship for a period of one year from date of original purchase from Lathem or from an authorized Lathem reseller. The conditions of this warranty and the extent of the responsibility of Lathem Time Corporation ("Lathem") under this warranty are listed below.

1. This warranty will become void when service performed by anyone other than an approved Lathem warranty service dealer results in damage to the product.
2. This warranty does not apply to any product which has been subject to abuse, neglect, or accident, or which has had the serial number altered or removed, or which has been connected, installed, adjusted, or repaired other than in accordance with instructions furnished by Lathem.
3. This warranty does not cover dealer labor cost for removing and reinstalling the machine for repair, or any expendable parts that are readily replaced due to normal use.
4. The sole responsibility of Lathem under this warranty shall be limited to repair of this product, or replacement thereof, at the sole discretion of Lathem.
5. If it becomes necessary to send the product or any defective part to Lathem or any authorized service dealer, the product must be shipped in its original carton or equivalent, fully insured with shipping charges prepaid. Lathem will not assume any responsibility for any loss or damage incurred in shipping.
6. **WARRANTY DISCLAIMER AND LIMITATION OF LIABILITY:** Except only the limited express warranty set forth above, the products are sold with no expressed or implied warranties of any kind, and the implied warranties of merchantability and fitness for a particular purpose are hereby expressly disclaimed. No warranties are given with respect to products purchased other than from Lathem or an authorized Lathem reseller and any such products are purchased "as is, with all faults." In no event will Lathem be liable for any direct, indirect, special, incidental or consequential damages arising out of or in connection with the delivery, use or inability to use, or performance of this product. In the event any limited remedy given herein shall be deemed to have failed of its essential purpose, Lathem's maximum liability shall be to refund the purchase price upon return of the product.
7. Proof of date of purchase from Lathem or an authorized Lathem reseller is required for warranty service on this product.
8. This Warranty grants specific legal rights. Additional legal rights, which may vary by locale, may also apply.
9. Should any difficulties arise with the performance of this product during warranty, or with any Lathem authorized service centers, contact Lathem Time for information.

Contents

Welcome	1
Package Contents	4
Install the FaceIN Terminal	5
Terminal Startup	7
Set up the Network Communications	7
Set up an Administrator	8
Terminal Setup	10
Changing settings at the Terminal.....	10
How do I disable daylight savings?.....	11
How do I change the displays time format?.....	11
How do I change the displays date format?	12
How do I activate the tamper alarm on the terminal?.....	12
How do I change the terminal's volume?.....	13
Add the Terminal	14
Add the terminal in PayClock	14
How do I add a FaceIN terminal?	14
Updating the FaceIN Terminal	15
Updating the FaceIN Terminal	15
How do I update a single terminal?	15
How do I update all terminals?	15
Enrolling Employee Faces	16
Guidelines.....	16
How do I enroll an employee?	17
Verification Methods	17
Using the FaceIN Terminal	21
Punching In / Out.....	22
Punching IN/Out - Face Verification	22
Punching IN/Out - PIN & Face Verification	22
Punching IN/Out - Card & Face Verification	23
Punching IN/Out - Card Verification.....	24

Polling the FaceIN Terminal	25
Polling the FaceIN Terminal.....	25
How do I poll a terminal?.....	25
How do I poll all terminals?	25
Auto - Polling the PayClock Terminals	26
How do I set up automatic polling?	26
Troubleshooting the FaceIN	28
General Troubleshooting	28
FaceIN Troubleshooting.....	28
Appendix A - Enrollment Guide	30
Appendix B - Access Control	32
Terminal Access Control Relay Connector Configuration	32
Connecting the Terminal to an Electromagnetic Lock	33
Connecting the Terminal to an Electromagnetic Lock using a Wiegand Signal.....	33
Terminal 26-Bit and 34-Bit Wiegand Formats.....	34
Appendix C - Exporting Punches to a USB Drive	35
Export the data to USB Thumb Drive	35
Import the data into PayClock.....	36
Appendix D - Add Employees at the Terminal	37
Adding an Employee at the FaceIN Terminal	37
Verification Methods	38
Appendix E - Record Management	42
Reviewing Punch Records.....	42
Clearing Punch Records.....	42
Appendix F - System Information	44
Appendix G - Terminal Specifications	46
Glossary of Terms	47
Index	47

S
Set up an Administrator 8
Set up Network Communications 7
System Information 44
T
Terminal Setup 10
Terminal Specifications 46
Terminal Startup 7
Terminal's 26-Bit and 34-Bit Wiegand Formats 34
Terminals Access Control Relay Connector Configuration 32
Troubleshooting 28
U
Updating the FaceIN 15
Using the FaceIN 21

Index

A

- Access Control 32
- Add the terminal from PayClock 14
- Adding Employees at the FaceIN Terminal 37
- Auto Poll 26

C

- Changing settings at the terminal 10
- Clearing Punches at the FaceIN 43
- Connecting the Terminal to an Electromagnetic Lock 33
- Connecting the Terminal to an Electromagnetic Lock using a Wiegand Signal 33

E

- Enrolling Employees 16
- Enrollment Guide 30
- Export the data to a USB Thumb Drive 35
- Exporting Punches to a USB Drive 35

F

- FaceIN Record Management 42
- FaceIN Troubleshooting 28
- Features & Specifications 1

G

- Getting Help 2

H

- How do I disable daylight savings? 11
- How do I enroll an employee? 17

I

- Importing the data into PayClock 36
- Install the FaceIN Terminal 5

P

- Package Contents 4
- Polling the FaceIN Terminal 25
- Punching In & Out 22

R

- Reviewing Capacity Information 44
- Reviewing Product Information 45
- Reviewing Punches on the FaceIN 42

Welcome

Reliability, functionality and ease of use are trademarks of the PayClock terminals. The FaceIN terminal connects to your network (LAN - PayClock software and FaceIN terminal have to be on the same subnet) for communications with the PayClock software. The terminal utilizes an “embedded facial recognition” system meaning that employees will punch in and out by presenting their face in front of the terminal’s “Dual Camera System”. The FaceIN terminal validates the face image and records the punch.

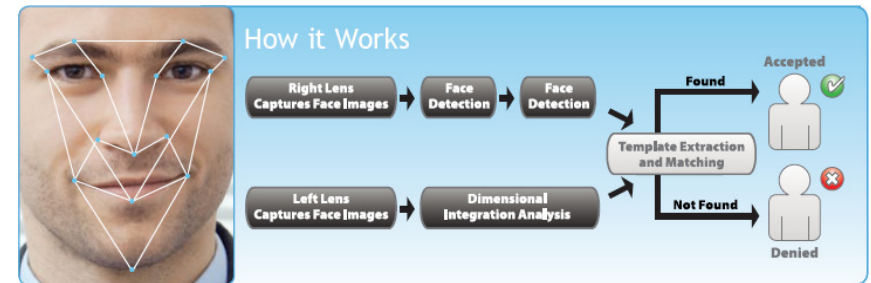

The FaceIN terminal offers a large color LCD display that displays employee information along with an audio prompt. Upon a successful validation the display will show the employee’s name, time of punch and an audio prompt identifying a successful punch.

Terminal Features and Specifications



- Embedded facial recognition system - Advanced DSP technology keeps the image processing and matching on the terminal.
- Accurate and fast identification - The industries leading “Dual Sensor” facial recognition technology.
- Reliable performance under different light environments - The terminal can work in different light conditions even in the dark. Over one year of market testing.
- Flexible I/O interfaces - Internet Protocol (TCP/IP) enables communications over the LAN. USB allows for employee data upload or punch download using a USB flash drive. The Ethernet Network Port is located on the back of the terminal and the USB Flash Drive Port is located on the bottom of the terminal.
- User friendly design - 3.5 inch color LCD screen for face positioning with voice prompt. No-touch authentication for the ultimate in hygiene.

Note: The proximity badge reader and access control relay are not available on the FR650 model.

Accessories

A number of accessories are offered to further enhance your PayClock system. Visit <http://shop.lathem.com> to purchase additional accessories.

Getting Help

You can access the help desk and answers to your issues in a number of different ways. In addition to resources within the PayClock software assistance may be accessed online, via email, via telephone, or through your dealer. Don't forget annual support contracts are also offered.

PayClock Help

The Online Help allows you to search through an index of help topics to locate the answer you need. To launch the Help click the Help button on the ribbon bar.

Troubleshooting

For answers to Frequently Asked Questions refer to the Troubleshooting section of this User Guide.

Glossary of Terms

Administrator

The FaceIN can have up to five administrators, the administrator function allows you review the device information, set up the network communications, set the time / date and reset the terminal to the factory defaults

Auto Poll

When a terminal is automatically polled, punch data is gathered and automatically added to the database allowing you to edit, export and report on the data.

Buddy Punching

When late or absent employees have co-workers punch the time clock for them.

User

An employee.

Appendix G - Terminal Specifications

- Employee Capacity : 500
- Record Capacity : 150,000
- Image Capacity : 70,000 Images
- Security Image Capacity : 4GB SD Card **(FR700)**
- Recognition Algorithm : Dual Sensor™ V2.0
- Lens : Specialized double lens
- Verification Method : Face Recognition; Pin & Face Recognition; Card Recognition **(FR700)**; Card & Face Recognition **(FR700)**
- Card Recognition : ID/IC card **(FR700)**
- Verification Speed : Less than 1 Second (500 Users)
- Keyboard : 4 x 4 Touch Keyboard
- LCD : 3.5 inch TFT Color Screen, 65,000 Bright Color, 320 x 240 Resolution
- Communication Method : Standard TCP/IP & USB Flash Drive
- Terminal Security Alarm : Yes
- Power : 12V DC, Working Current 500mA
- Environment Light : 0-5000Lux
- Working Distance : 12 - 32 inches
- Working Temperature : 32°F - 104°F
- Working Humidity : 20% - 80%
- Size : 7.87 x 3.74 x 4.53 inches
- Weight : 1.11 lbs
- Installation Method Wall Hanging

Online and Email Support

Lathem.com provides access to numerous support resources that will allow you maximize your use of PayClock. Help may be accessed by visiting the following link: <http://support.lathem.com>

On the Support page you may also submit a question through our online knowledgebase and one of our technicians will respond to your inquiry within 24 hours. Email support is free to all registered users.

Telephone Support

The help desk is available between the hours of 8am and 7pm Monday through Friday. Please call **(800) 241-4990** to speak with our help desk. You will receive free technical support for the first 30 days after your initial call. After that period you may purchase an Annual Support Agreement which will cover all calls for one year or you may pay a per-call fee.

Annual Support Agreements

Annual support contracts are designed to keep your terminal and PayClock software working seamlessly. For a single annual fee your Support Agreement offers the following advantages:

- Unlimited toll-free telephone support (versus a per-call fee) and priority status for calls
- Unlimited access to the extensive library of web-based tips and FAQs
- Quick exchanges for damaged or broken terminal thereby reducing downtime
- Extended parts and labor warranty helps you to save money on repairs needed after the regular product warranty has expired

To learn more about annual support contracts and to make a purchase, contact us at (800) 241-4990 or visit <http://www.lathem.com/support/support-plans.aspx>

Package Contents

Please verify that your package includes ALL of the following items. If your package is missing an item, please call our help desk at (800) 241-4990.

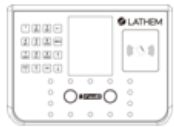

FacelN Terminal



Mounting-Plate



AC Wall Adapter



User's Guide



Ethernet Cable



Mounting Screw Packet

4 Screws to install the mounting-plate to the wall
4 Anchors (use for masonry wall installation)
2 Philips Head screws to install the FacelN terminal to the mounting-plate

Recommended Installation Tools



Tape Measure



Pencil



Philips Head Screw Driver



Optional - Power Drill & Drill Bits

- At the FacelN terminal press the MENU key. Administrator verification is required.
- The administrator should present and position their face for a facial scan. The Functions Menu will display upon a successful verification.
- Press **5** or select the System Info. menu and press **OK**.
- Press **2** or select the Product Info. menu and press **OK**.
 - IP - Displays the IP address configured for the terminal.
 - Mask - Displays the subnet mask address configured for the terminal.
 - Gate - Displays the gateway address configured for the terminal.
 - MAC - Displays the terminal's MAC address.
 - SN - Displays the terminal's serial number.
 - Version - Displays the terminal's firmware version.
 - Res Num - Displays the firmware resource number. (Not currently used.)
- Press **ESC**, **ESC** and **ESC** again to return to the normal time/date screen.

Appendix F - System Information

The System Info function allows you review the terminal's capacity and product information.

Reviewing Capacity Information

- At the FaceIN terminal press the MENU key. Administrator verification is required.
- The administrator should present and position their face for a facial scan. The Functions Menu will display upon a successful verification.
- Press **5** or select the System Info. menu and press **OK**.
- Press **1** or select the Capacity Info. menu and press **OK**.
 - Registered User - Displays how many employees have been updated to the terminal.
 - User Cap. - Displays how many employees are supported on the terminal.
 - Record Num. - Displays how many punches are in memory from facial recognition punches.
 - Record Cap. - Displays how many facial recognition punches the terminal will hold in memory.
 - Photo Num. - Displays how many punches are in memory from the card verification method.
 - Photo Cap. - Displays how many punches from the card verification method the terminal will hold in memory.
- Press **ESC**, **ESC** and **ESC** again to return to the normal time/date screen.

Reviewing Product Information

Install the FaceIN Terminal

Step 1: Select a site to install your FaceIN terminal that will be convenient to employees clocking in and out. When deciding where the terminal will be installed, keep in mind that an 115vAC power outlet should be within 6 feet of the mounting location as well as a connection to the network (LAN).

Note about Direct Sunlight - It is not recommended to have the terminal mounted in a location where it is exposed to direct sunlight. This could be troublesome during the registration process.

Step 2: After selecting the appropriate installation site, use the terminal to determine the appropriate height. Have the shortest employee stand in front of the terminal. Hold the terminal on the wall so that this employee can comfortably center their face in the LCD display window. Mark the height of the terminal on the wall. **Note:** Taller employees can easily adjust their stance to center their face in the LCD display window.

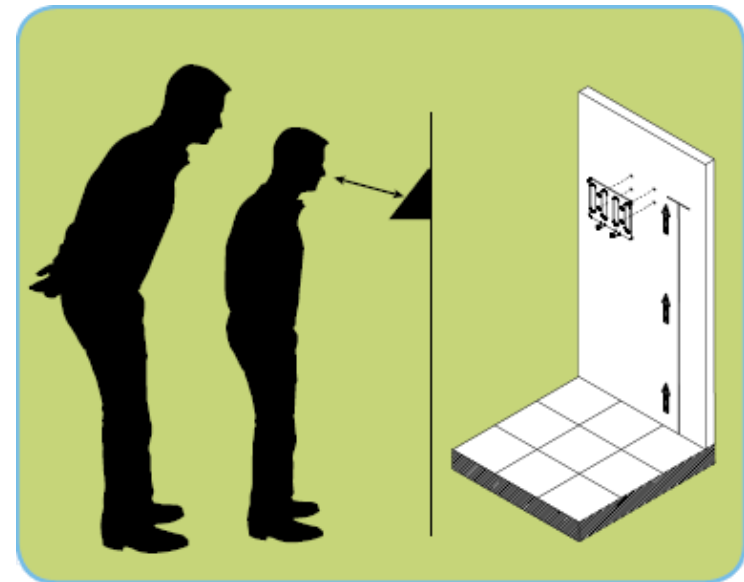

Install the mounting-plate to the wall using the supplied screws. For sheetrock walls, drill a 3/16" diameter hole through each of the four screw locations; each approx 1-1/2" deep. Install the plastic "anchors" included in the mounting screw packet.

Step 3: Plug the RJ45 network cable into the Ethernet port and the Power Adapter plug into the Power Adapter port which is located in the compartment on the back of the terminal.

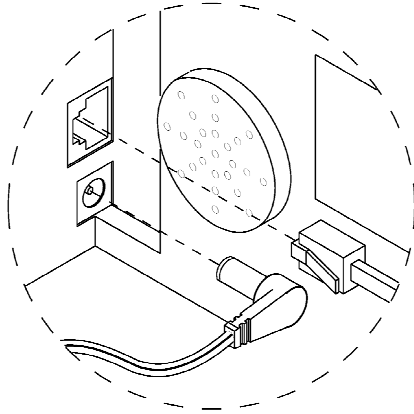

Step 4: Align the FacelN terminal with the pins on the mounting-plate and secure the two together with the 2 Philips head screws. Be careful not to pinch the AC cord or network cable.

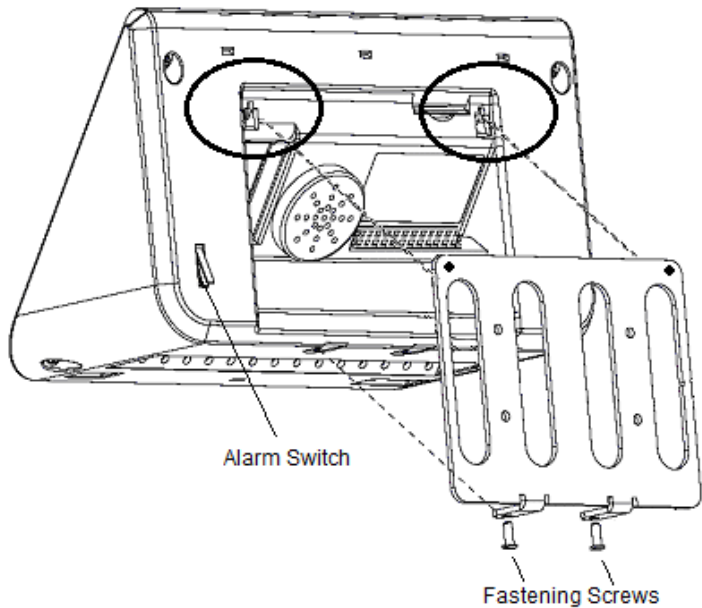

When finished, plug the power adapter into an AC wall outlet.

Clearing Punch Records

The Record Management function allows you review punch data and clear records in the terminals memory.

Warning: Use extreme caution when clearing records. Once the records are cleared they can not be restored!

- At the FacelN terminal press the MENU key. Administrator verification is required.
- The administrator should present and position their face for a facial scan. The Functions Menu will display upon a successful verification.
- Press **3** or select the Record Management menu and press **OK**.
- Press **2** or select the Clear Record menu and press **OK**.

Warning: Use extreme caution when clearing records. Once the records are cleared they can not be restored!

- Proceed with caution, all data and settings will be lost!
- If you are sure press **OK** to continue. This will delete all punch records in the terminal.
- The screen will display "Clearing...Please Wait...", next "Records Cleared!" will display and the terminal will return to the Record Management menu.
- Press **ESC** and **ESC** again to return to the normal time/date screen.

Appendix E - Record Management

The Record Management function allows you review punch data and clear records in the terminals memory.

Warning: Use extreme caution when clearing records. Once the records are cleared they can not be restored!

Reviewing Punch Records

- At the FaceIN terminal press the MENU key. Administrator verification is required.
- The administrator should present and position their face for a facial scan. The Functions Menu will display upon a successful verification.
- Press **3** or select the Record Management menu and press **OK**.
- Press **1** or select the Record Inquiry menu and press **OK**.
- At the Input User No. field enter the PIN for the desired employee or leave the field at ALL.
- Press the down arrow key to move the cursor to the Start Time field.
- Using the index/numeric keys enter the year, month and date where you wish to start the review. The cursor will automatically move to the End Time field.
- Using the index/numeric keys enter the year, month and date where you wish to end the review.
- Press **OK**. The punch records will display for the selected employee and time period. Use the up/down arrows to scroll through the list of punches.

Terminal Startup

After completing the installation and power-up the terminal will display the normal screen with the date, day of week and time.

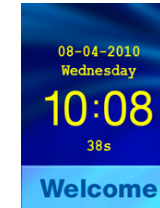

You are now ready to set up the network communications and define the initial administrator. **Note:** You must set up at least one administrator.

Set up the Network Communications

The FaceIN terminal must be configured to communicate with the PayClock software over the network. You may have to contact your network administrator if you are unsure how to set up the network communications.

- Press the **MENU** key. The Functions Menu will open.
- Press **4**. The System Setting menu will open.
- From the System Setting menu press **2 - Set Network**.
- Enter the IP Address for the terminal and press **OK**.
- Enter the Mask Code and press **OK**.
- Enter the Gateway Address and press **OK**.
- Enter the Host computers IP address and press **OK**. (FR650 only)
- The FaceIN terminal will restart automatically.

Note: You may have to enter leading zeros when entering the addresses. For example the address **10.0.0.1** would be entered as **010.000.000.001** at the terminal.

Set up an Administrator

After setting up the network communications you will need to set up at least one administrator. **Note:** You can have up to 5 administrators.

- Press the **MENU** key. The Functions Menu will open.
- Press **1**. The Set Admin menu will open.
- From the Set Admin menu press **1 - Admin 1**.
- The image collecting screen will display.
- Position the face in the middle of the two cameras with 9 to 25 inches between the face and the terminal.
- The image collecting screen will start the face recognition enrollment.
- Perform 2 small head circles to the right.
- Perform 2 small head circles to the left.
- Move the face closer to the terminal until the white dashed square appears.
- Move the face back until there is 9 to 25 inches between the face and the terminal.
- Turn the head fully to the right.
- Turn the head fully to the left.
- Raise the head up slightly.
- Lower the head down slightly.
- Move the face back from the terminal until there is 9 to 25 inches between the face and the terminal (if adjust position message is still displaying).
- Resume small head circles to the right (if adjust position message is still displaying).
- The progress bar at the bottom of the screen will display the process of the imaging.

- Resume small head circles to the right (if adjust positioning message is still displaying).
- The progress bar at the bottom of screen will display the process of the imaging.
- When the face is enrolled the terminal will display, “Permit Open Door?” press **ESC**.
- When “Permit Attendance?” displays, press **OK**. Note: You must press OK; otherwise punches will not be recorded for polling.
- The screen will display “Finished” and will return to the “Input User No” screen. Continue with the next employee or press **ESC, ESC** and **ESC** again to return to the normal time/date screen.

- The screen will display “Finished” and will return to the “Input User No” screen. Continue with the next employee or press **ESC**, **ESC** and **ESC** again to return to the normal time/date screen.

Card and Face Verification Method Selected

(FR700 only)

When enrolling employee faces, take the following into consideration:

Eye Glasses - It is recommended for the employee to enroll with the eye glasses on for half the process, then remove the eye glasses and complete the registration.

Hair Style - If the employee has a hair style that has their hair covering or blocking their eyes, move the hair away from the eyes during the registration process.

- When “Please Swipe Card” displays, present the card at the terminal.
- Position the employee so the face is in the middle of the two cameras with 9 to 25 inches between the face and the terminal.
- The image collecting screen will display, start the face recognition enrollment.
- Perform 2 small head circles to the right.
- Perform 2 small head circles to the left.
- Move the face closer to the terminal until the white dashed square appears.
- Move the face back until there is 9 to 25 inches between their face and the terminal.
- Turn the head fully to the right.
- Turn the head fully to the left.
- Raise the head up slightly.
- Lower the head down slightly.
- Move the face back from the terminal until there is 9 to 25 inches between the face and the terminal (if adjust positioning message is still displaying).

When the face is successfully enrolled the terminal will display, “Add as User?”.

Ask yourself this question.

Will the administrator be using the door access function or punching In and Out on the terminal?

Yes - The administrator will be using the door access function or punching In and Out at the terminal.

- If the administrator will be punching In and Out or using the door access function at the terminal, press the **OK** key. The Input User No screen will display.
- Use the numeric keys to enter the user number and press OK. This should be the same as the PIN number you will enter into the PayClock software. The user number can be from 1 to 9999.
- Using the index/numeric keys enter a name. This should be the same as the first name you will enter into the PayClock software. After pressing the desired index/numeric key, use the ↑/↓ to move through the available letters. To change to caps press the index/numeric key with the desired letter and press the **ESC** key. The letter group will change to caps. After entering the name press the **OK** key.
- Select the verification method to use for this user.

No - The administrator will **not** be using the door access function or punching In and Out at the terminal.

- If the administrator will not be punching In and Out or using the door access function at the terminal press the **ESC** key.
- The screen will display “Register Finished” and will return to the “Set Admin” menu. Press **ESC** and **ESC** again to return to the normal time/date screen.

Terminal Setup

The FaceIN terminal is designed with default settings so that it will be ready for use after being updated with the employees. While these default settings allow you to get up and running faster, you can make changes to the settings if desired.

These default settings are:

- Daylight Savings Time: Daylight savings is enabled.
- Time Format: The display will show the hours in a 24 hour (0-23) format.
- Date Format: The display will show the date in the MM-DD-YYYY format.
- Tamper Alarm: The alarm that will sound if the terminal is removed from the wall is enabled. (FR700 only)
- Volume: The sound level is set to medium.

Changing settings at the Terminal

The default settings that can be changed by the administrator at the terminal are:

- Daylight Savings Time: Daylight savings is enabled.
- Time Format: The display will show the hours in a 24 hour (0-23) format.
- Date Format: The display will show the date in the MM-DD-YYYY format.
- Tamper Alarm: The alarm that will sound if the terminal is removed from the wall is enabled.
- Volume: The sound level is set to medium.

- Perform 2 small head circles to the left.
- Move the face closer to the terminal until the white dashed square appears.
- Move the face back until there is 9 to 25 inches between their face and the terminal.
- Turn the head fully to the right.
- Turn the head fully to the left.
- Raise the head up slightly.
- Lower the head down slightly.
- Move the face back from the terminal until there is 9 to 25 inches between the face and the terminal (if adjust positioning message is still displaying).
- Resume small head circles to the right (if adjust positioning message is still displaying).
- The progress bar at the bottom of screen will display the process of the imaging.
- When the face is enrolled the terminal will display, "Permit Open Door?" press **ESC**.
- When "Permit Attendance?" displays, press **OK**. **Note:** You must press OK; otherwise punches will not be recorded for polling.
- The screen will display "Finished" and will return to the "Input User No" screen. Continue with the next employee or press **ESC**, **ESC** and **ESC** again to return to the normal time/date screen.

Card Verification Method Selected

(FR700 only)

- When "Please Swipe Card" displays. Present the card at the terminal.
- When the card is enrolled the terminal will display, "Permit Open Door?" press **ESC**.
- When "Permit Attendance?" displays, press **OK**. **Note:** You must press OK; otherwise punches will not be recorded for polling.

- Press **1** or select the Register User menu and press **OK** to add a new employee at the terminal.
- The Input User No. screen will display.
- Using the index/numeric keys enter the User Number and press **OK**. **Note:** This is the number that will be entered into the PayClock software as the employees PIN number. The number has to be unique.
- The Input Name screen will display.
- Using the index/numeric keys enter a name. This should be the same as the first name you will enter into the PayClock software. After pressing the desired index/numeric key, use the \uparrow/\downarrow to move through the available letters. To change to caps press the index/numeric key with the desired letter and press the **ESC** key. The letter group will change to caps. After entering the name, press the **OK** key.
- With the employee standing at the ready select the verification method to use for the employee.

Verification Methods

Typically for a normal employee you would select Face recognition, for a temporary employee select Card recognition. For higher security select either Pin and Face or Card and Face recognition.

Face / Pin and Face Verification Method Selected

When enrolling employee faces take the following into consideration:

Eye Glasses - It is recommended for the employee to enroll with the eye glasses on for half the process, then remove the eye glasses and complete the registration.

Hair Style - If the employee has a hair style that has their hair covering or blocking their eyes, move the hair away from the eyes during the registration process.

- Position the employee so the face is in the middle of the two cameras with 9 to 25 inches between the face and the terminal.
- The image collecting screen will display. Start the face recognition enrollment.
- Perform 2 small head circles to the right.

How do I disable daylight savings?

By default day light savings is enabled and is set to change on the 2nd Sunday in March and the 1st Sunday in November. You will have to disable the function if your region doesn't observe day light savings. **Note:** Open or Close will display to the right of Set DST. **Open** identifies DST is **enabled**, **Close** identifies DST is **disabled**.

- At the FaceIN terminal press the MENU key. Administrator verification is required.
- The administrator should present and position the face for a facial scan. The Functions Menu will display upon a successful verification.
- Press 4 or select the System Setting menu and press OK.

FR650 Model - Press 5 or select the Set Date and Time menu and press **OK**.

FR700 Model - Press 6 or select the Set Date and Time menu and press **OK**.

- Press 2 or select the Set DST menu and press OK.
- The screen will display "Use DST?" press ESC. This will disable the daylight savings function.
- After a few seconds the system will return to the "Set Date and Time" screen. Continue making changes to the terminals system settings or press ESC, ESC and ESC again to return to the normal time/date screen.

How do I change the displays time format?

The time format selection will determine how the hours will show on the terminal display.

- At the FaceIN terminal, press the **MENU** key, administrator verification is required.
- The administrator should present and position the face for a facial scan. The Functions Menu will display upon a successful verification.
- Press **4** or select the System Setting menu and press **OK**.

FR650 Model - Press 5 or select the Set Date and Time menu and press **OK**.

FR700 Model - Press 6 or select the Set Date and Time menu and press **OK**.

- Press **3** or select the Set Time Format menu and press **OK**.
- Press **1** for 12 hour (AM/PM) or **2** for 24 hour (0-23).
- After a few seconds the system will return to the “Set Date and Time” screen. Continue making changes to the terminals system settings or press **ESC**, **ESC** and **ESC** again to return to the normal time/date screen.

How do I change the displays date format?

The date format selection will determine how the date will show on the terminal display.

- At the FaceIN terminal press the **MENU** key. Administrator verification is required.
- The administrator should present and position the face for a facial scan. The Functions Menu will display upon a successful verification.
- Press **4** or select the System Setting menu and press **OK**.

FR650 Model - Press 5 or select the Set Date and Time menu and press **OK**.

FR700 Model - Press 6 or select the Set Date and Time menu and press **OK**.

- Press **4** or select the Set Date Format menu and press **OK**.
- Press **1** for YYYY-MM-DD (2011-03-01) or **2** for MM-DD-YYYY (03-02-2011). **Note:** March 01, 2011 was used in the example above.
- After a few seconds the system will return to the “Set Date and Time” screen. Continue making changes to the terminals system settings or press **ESC**, **ESC** and **ESC** again to return to the normal time/date screen.

How do I activate the tamper alarm on the terminal?

The terminal has a feature where if it were removed from the wall mounting-plate an alarm can sound. The alarm is turned off by default. (FR700 only)

Appendix D - Add Employees at the Terminal

Employees can be added at the FaceIN terminal first and then added in the PayClock software later. This could be useful when a new employee starts work before having a chance to add them to the PayClock software.

Important Note: The number you enter for the User No. at the FaceIN terminal has to match what is entered for the Employee PIN Number in the PayClock software. These numbers are how the software identifies which punches go with which employee.

You should follow these recommended steps if adding the employees at the FaceIN terminal.

1. Add and enroll the employee’s face at the FaceIN terminal.
2. Have the employee punch In and Out.
3. Add the employee in the PayClock software **before** polling and processing payroll.

Adding an Employee at the FaceIN Terminal

- At the FaceIN terminal press the MENU key. Administrator verification is required.
- The administrator should present and position their face for a facial scan. The Functions Menu will display upon a successful verification.
- Press **2** or select the User Management menu and press **OK**.

- Press **1** or select the Export Records menu and press **OK**.
- When the export is complete the data will be saved to a file named TIME .TXT (there are 3 spaces between TIME and .TXT) on the root of the USB Flash drive.
- After a few seconds the system will return to the “Functions Menu” screen.
- Press the **ESC** key. The terminal will return to the normal time/date display.
- Unplug the USB Flash drive.

Import the data into PayClock

- Plug the USB Flash Drive into a USB port on your computer.
- Open PayClock and select the Terminal Manager tab on the ribbon bar. The Terminal Manager window will open.
- Click on a FaceIN terminal in the list. The Import Punches button will become active.
- Click the Import Punches button. The Open window will display.
- Navigate to the location of the TIME .TXT file. Typically located on the USB Flash Drive plugged into your computer.
- Click the Open button, the punch data will be imported into the PayClock database.

- At the FaceIN terminal press the **MENU** key. Administrator verification is required.
- The administrator should present and position their face for a facial scan. The Functions Menu will display upon a successful verification.
- Press **4** or select the System Setting menu and press **OK**.
- Press **7** or select the Set Remove Alarm menu and press **OK**.
- Press **1** for Open. This will enable the alarm to sound if the terminal is removed from the mounting-plate.
- Press **2** for Close. This will disable the alarm. If the terminal is removed from the mounting-plate the alarm will not sound.
- After a few seconds the system will return to the “System Setting” screen. Continue making changes to the terminals system settings or press **ESC** and **ESC** again to return to the normal time/date screen.

How do I change the terminal’s volume?

The terminals sound level is set to medium (middle) by default; it can be set to low, medium or high.

- At the FaceIN terminal press the **MENU** key. Administrator verification is required.
- The administrator should present and position the face for a facial scan. The Functions Menu will display upon a successful verification.
- Press **4** or select the System Setting menu and press **OK**.
- Press **1** or select the Set Volume menu and press **OK**.
- Press **1** for high, **2** for medium (middle) or **3** for low.
- Press **1** for 12 hour (AM/PM) or **2** for 24 hour (0-23).
- After a few seconds the system will return to the “System Setting” screen. Continue making changes to the terminal’s system settings or press **ESC**, **ESC** and **ESC** again to return to the normal time/date screen.

Add the Terminal

After setting up the FaceIN add it to your PayClock system. Once the terminal is added to the PayClock system employees can be added. After adding the employees update the terminal and the employee face's can be enrolled.

Add the terminal in PayClock

The Maintenance button group under the Terminal Manager tab is used to add or delete FaceIN terminals that are connected to the PayClock system.

How do I add a FaceIN terminal?

- Open PayClock and select the Terminal Manager tab on the ribbon bar.
- Click the Add Terminal button. The Select Terminal Type window will open.
- Select FaceIN from the drop down list and click OK.
- The FaceIN terminal properties will display on the right.
- From the Connection tab enter the name for the terminal under Device Nickname.
- Enter the terminal's IP Address in the IP Address field; this is the address that was set up for the terminal at the FaceIN terminal.
- Click Save.
- Click the Test Connection button to verify communications with the FaceIN terminal.

Appendix C - Exporting Punches to a USB Drive

The USB Functions menu allows you to export punch data to a USB thumb drive and then import the data into the PayClock database using the PayClock software.

Important Note: If you don't have an Ethernet connection you can transfer punch data from the terminal to the PayClock software using a standard USB thumb drive.

Export the data to USB Thumb Drive

The Poll button group is used to poll or retrieve data from a single terminal or all terminals. When a terminal is polled punch data will be added to the database allowing you to edit, export and report on the data.

- Press the **ESC** key to force the terminal to the normal time/date screen.
- Insert the USB Flash drive into the USB port on the bottom of the terminal. Administrator verification is required.
- The administrator should present and position their face for a facial scan. The Functions Menu will display upon a successful verification.
- The Functions Menu will display after administrator verification.

Note: Due to compatibility issues not all USB Flash drives are compatible and may not work with the terminal. It is not recommended to use a USB Flash drive formatted as NTFS

Enrolling Employee Faces

The FaceIN terminal utilizes an “embedded facial recognition” system. This means that employees will punch in and out by presenting their face in front of the terminal’s “Dual Sensors”. The FaceIN terminal verifies the face image and records the punch. When you’re ready you simply poll the terminal to add the punches to the database.

See Appendix A - Enrollment Guide for a detailed pictorial.

Guidelines

- The FaceIN terminal is for use indoors; do not position the terminal in direct sunlight.
- Use normal facial expressions and avoid wearing sunglasses.
- If glasses or a hat is worn, please take the glasses and/or hat off halfway through the enrollment process for better face recognition.
- Bend into the camera, keeping the distance between the face and screen at 9 to 25 inches for best results.
- Keep the face centered between the 2 cameras.
- If the green lined frame displays when the employees face is successfully being detected.
- If the white dashed frame appears, the employees face can not be recognized, so please have the employee adjust their positioning.

Connecting the Terminal to an Electromagnetic Lock

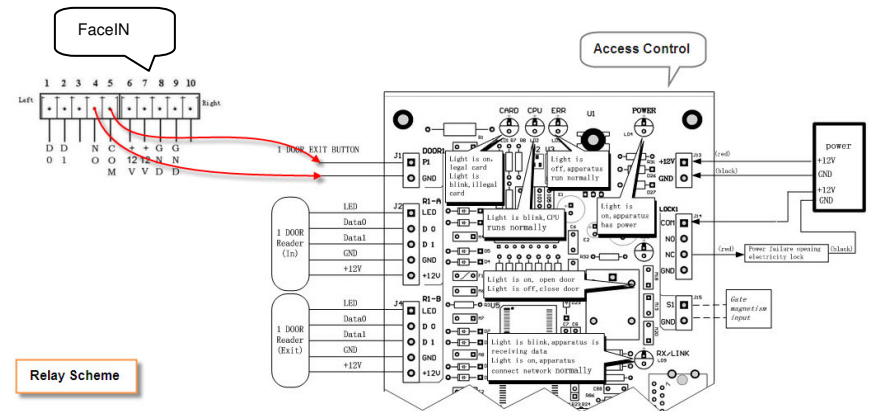

Connecting the Terminal to an Electromagnetic Lock using a Wiegand Signal

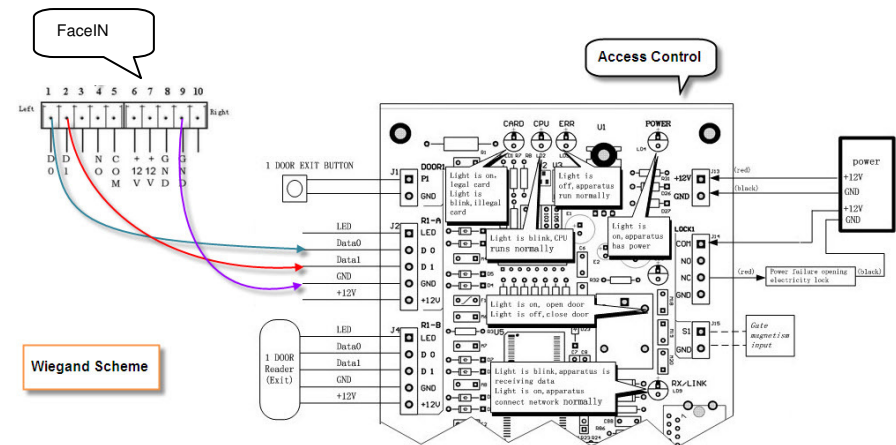

Appendix B - Access Control

Access control is only available in the FR700 model. Use the FR700's internal access control relay to integrate with a facilities entry access control system.

Important Note: When enrolling an employee make sure to select **OK** at the **Permit Open Door?** prompt.

Terminal Access Control Relay Connector Configuration

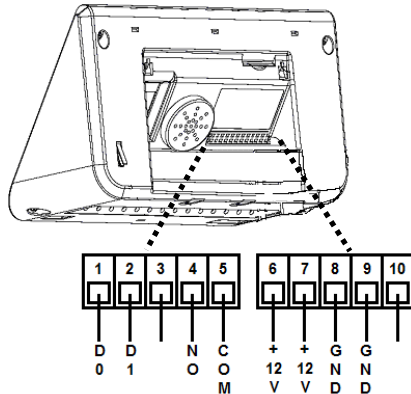

1 = D0 - Output to Wiegand Controller	6 = +12V - 12 volt output to external device
2 = D1 - Output to Wiegand Controller	7 = +12V - 12 volt output to external device
3 = Not Used	8 = GND - Ground connection
4 = NO - Normally open internal dry contract relay output	9 = GND - Ground connection
5 = COM - Common output for internal dry contract relay	10 = Not Used

How do I enroll an employee?

- At the FaceIN terminal press the **MENU** key. Administrator verification is required.
- The administrator should present and position themselves for a facial scan. The Functions Menu will display upon a successful verification. **Note:** The FaceIN terminal requires administrator verification in order to enroll employee faces.
- Press **2** or select User Management and press **OK**, the User Management menu will display.
- Press **2** or select the Modify User menu and press **OK**.
- Use the numeric keys to enter the user number and press **OK**. The user number is the same as the badge number that was set up in the PayClock software.
- The employee's first name will display. Press **OK** to continue.
- With the employee standing at the ready select the verification method to use for the employee.

Verification Methods

Typically for a normal employee you would select Face recognition, for a temporary employee select Card recognition, for higher security select either Pin and Face or Card and Face recognition.

Face / Pin and Face Verification Method Selected

When enrolling employee faces take the following into consideration:

Eye Glasses - It is recommended for the employee to enroll with the eye glasses on for half the process, then remove the eye glasses and complete the registration.

Hair Style - If the employee has a hair style that has their hair covering or blocking their eyes, move the hair away from the eyes during the registration process.

- Position the employee so the face is in the middle of the two cameras with 9 to 25 inches between the face and the terminal.
- The image collecting screen will display, start the face recognition enrollment.

- Perform 2 small head circles to the right.
- Perform 2 small head circles to the left.
- Move the face closer to the terminal until the white dashed square appears.
- Move the face back until there is 9 to 25 inches between their face and the terminal.
- Turn the head fully to the right.
- Turn the head fully to the left.
- Raise the head up slightly.
- Lower the head down slightly.
- Move the face back from the terminal until there is 9 to 25 inches between the face and the terminal (if adjust positioning message is still displaying).
- Resume small head circles to the right (if adjust positioning message is still displaying).
- The progress bar at the bottom of screen will display the process of the imaging.
- When the face is enrolled the terminal will display, “Permit Open Door?” press **ESC**.
- When “Permit Attendance?” displays press **OK**. Note: You must press OK; otherwise punches will not be recorded for polling.
- The screen will display “Finished” and will return to the “Input User No” screen. Continue with the next employee or press **ESC**, **ESC** and **ESC** again to return to the normal time/date screen.

Card Verification Method Selected

(FR700 only)

The card verification method is typically used for temporary employees. This verification method only requires that the employee present their badge and then have a snapshot taken.

The terminal only verifies the badge, it doesn't verify the employee, it simply takes a snapshot of the person presenting the badge. This allows the user to verify that the correct employee presented the

Enrollment Guide (cont.)

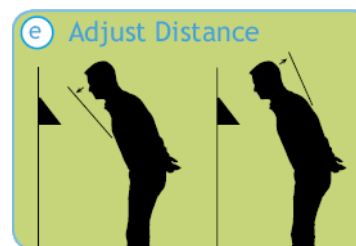

Slowly move your face closer until the white-dashed frame appears and then move away until the white-dashed frame appears.

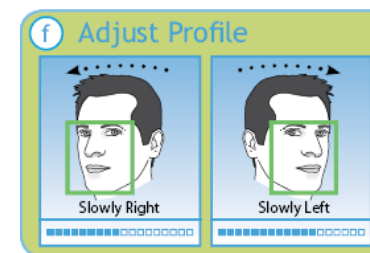

Slowly turn your head fully to the right, and then fully to the left, all the while keeping your eyes centered on the screen.

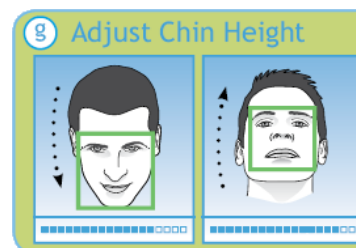

Tilt the head down slightly (chin lowered) while keeping your eyes on the screen, then tilt the head back slightly (chin upward).

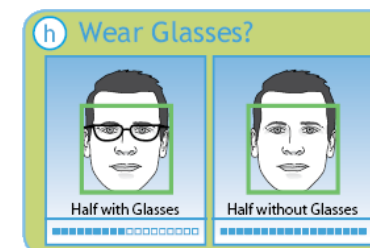

If you wear glasses all of the time, or on occasion, you must initially enroll with your glasses on (sunglasses or dark tinted glasses are not allowed). Once the progress bar indicates enroll is 50% complete, REMOVE YOUR GLASSES and complete the enrollment without your glasses on.

Appendix A - Enrollment Guide

Follow these guidelines for trouble-free enrollments.

During the enrollment process the employee should keep their eyes centered on the screen at all times. Try to keep a solid green box around your face by following the steps below.

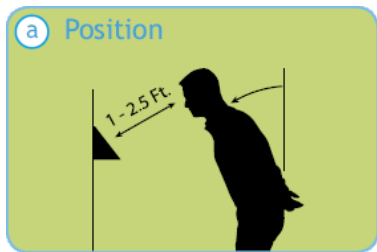

Position yourself and bend at the waist to bring your face 1 - 2.5 ft. from the screen on the terminal.

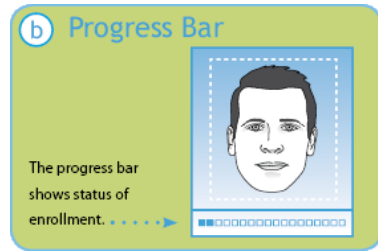

The line of squares at the bottom of the screen indicate how much data is needed to complete the enrollment.

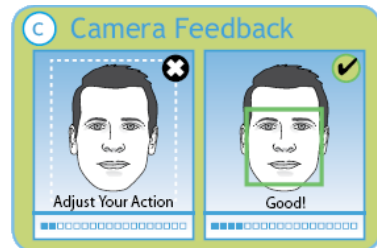

The white dashed box is preparing to locate points. Identification images will only be taken when the green box appears around your face.

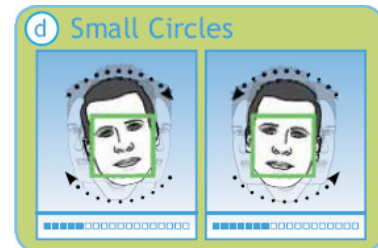

Slowly make an imaginary circle with your nose. Two small circles to the right and two to the left while **keeping your eyes centered on the screen.**

badge and no buddy punching (when late or absent employees have co-workers punch the time clock for them) has taken place.

- When “Please Swipe Card” displays present the card at the terminal.
- When the card is registered the terminal will display, “Permit Open Door?” press **ESC**.
- When “Permit Attendance?” displays, press **OK**. Note: You must press OK; otherwise punches will not be recorded for polling.
- The screen will display “Finished” and will return to the “Input User No” screen. Continue with the next employee or press **ESC**, **ESC** and **ESC** again to return to the normal time/date screen.

Card and Face Verification Method Selected

(FR700 only)

When enrolling employee faces take the following into consideration:

Eye Glasses - It is recommended for the employee to enroll with the eye glasses on for half the process, then remove the eye glasses and complete the registration.

Hair Style - If the employee has a hair style that has their hair covering or blocking their eyes, move the hair away from the eyes during the registration process.

- When “Please Swipe Card” displays, present the card at the terminal.
- Position the employee so the face is in the middle of the two cameras with 9 to 25 inches between the face and the terminal.
- The image collecting screen will display. Start the face recognition enrollment.
- Perform 2 small head circles to the right.
- Perform 2 small head circles to the left.
- Move the face closer to the terminal until the white dashed square appears.
- Move the face back until there is 9 to 25 inches between their face and the terminal.

- Turn the head fully to the right.
- Turn the head fully to the left.
- Raise the head up slightly.
- Lower the head down slightly.
- Move the face back from the terminal until there is 9 to 25 inches between the face and the terminal (if adjust positioning message is still displaying).
- Resume small head circles to the right (if adjust positioning message is still displaying).
- The progress bar at the bottom of screen will display the process of the imaging.
- When the face is enrolled the terminal will display, “Permit Open Door?” press **ESC**.
- When “Permit Attendance?” displays, press **OK**. Note: You must press OK; otherwise punches will not be recorded for polling.
- The screen will display “Finished” and will return to the “Input User No” screen. Continue with the next employee or press **ESC**, **ESC** and **ESC** again to return to the normal time/date screen.

Note: If changes are needed, from the Functions Menu press **4 - System Setting** and then **2 - Set Network**. Make the needed adjustments and press **OK** to save the changes.

#2 Make sure that the network communications settings are correct in the PayClock software. To check the settings:

- Open PayClock and click on the Terminal Manager tab. The Terminal Manager window will open.
- Select the FaceIN terminal from the list; verify that the IP Address on the Connection tab matches what was configured on the terminal.

If after going through each item above you are still not communicating with the terminal, have the network administrator or IT person make sure there aren't any issues with the network.

When an employee presents their face it is not recognized.

- If the employee's facial appearance has changed, re-enroll the employee.
- Make sure the employee is presenting their face within range of the terminal, within 9 to 25 inches of the front of the terminal.

How do I restart the FaceIN terminal if it stops or appears to hang up?

- Disconnect the AC power. Wait a few seconds and reconnect.
- Press the RESET button on the bottom of the terminal.

Is the FaceIN terminal waterproof?

NO, the terminal is not waterproof! Make sure you keep the terminal away from water or a wet/damp environment.

How do I clean the FaceIN terminal?

Use only a soft cloth or similar material to clean the screen and front of the terminal. Avoid using water or cleaners.

Can I place the FaceIN terminal outside?

It is not recommended to place the terminal in a low temperature environment. The working temperature for the screen and other parts in the terminal are normal indoor temperatures.

Troubleshooting the FaceIN

If the PayClock software doesn't communicate with the FaceIN try these suggestions:

General Troubleshooting

- Make sure that all connections are secure and the cable is in tact.
- Make sure that the network cable is securely connected to the Ethernet port on the terminal.
- Make sure that the terminal's power supply is securely connected to an electrical outlet.
- Make sure that the power supply is securely connected to the terminal and the unit is powered up.

FaceIN Troubleshooting

The FaceIN terminal will not communicate with the PayClock software.

#1 Make sure that the network communications settings are correct at the terminal, to check the settings:

- At the FaceIN terminal press the **MENU** key. Administrator verification is required. The Functions Menu will open.
- Press **5**. The System Info. menu will open.
- From the System Info. menu, press **2 - Product Info**.
- Verify the addresses for the IP, Mask and Gate.
- To exit press **ESC**.

Using the FaceIN Terminal

The FaceIN will be ready for use when the facial registration process is complete.



To punch, the employee will simply approach and look at the terminal. Within seconds they are identified and punched In or Out.

Upon successful verification the terminal will play a confirmation sound and the screen will display the employee's first name and time of punch.

Punching In / Out

Employees can punch by presenting their face or a badge.

Punching IN/Out - Face Verification

- The employee should step towards the terminal and stop when within 9 - 25 inches; the terminal will detect the employee and start the face recognition automatically.
- With the face detected, the screen will display a green radar screen rotating clockwise over the employee's image. A message will display at the bottom of the screen guiding the employee.
- When the employee's face is in the correct position, a green lined frame will display on the screen, and a green bar will scan the employee's image from top to bottom.
- During the face recognition process, the terminal will provide guidance for the employee, such as: "Please Get Closer", "Please Get Farther" or "Adjust Your Action".
- Upon successful verification the terminal will play a confirmation sound and the screen will display the employee's first name and time of the punch.

Punching IN/Out - PIN & Face Verification

- Press the backspace key "←", at the Input User No. screen enter the employee's PIN and press OK.
- The employee should step towards the terminal and stop when within 9 - 25 inches; the terminal will detect the employee and start the face recognition automatically.
- With the face detected, the screen will display a green radar screen rotating clockwise over the employee's image. A message will display at the bottom of the screen guiding the employee.
- When the employee's face is in the correct position, a green lined frame will display on the screen, and a green bar will scan the employee's image from top to bottom.

- Continue adding the times the poll is to occur.
- Select the days of the week to have the auto-poll active. The default is Monday through Friday.
- Click Save to keep your changes.
- The automatic polling will activate on the desired day(s) at the minutes selected.

Auto - Polling the PayClock Terminals

PayClock can be configured to automatically poll the FaceIN terminal(s). When a terminal is automatically polled punch data is gathered and automatically added to the database allowing you to edit, export and report on the data.

How do I set up automatic polling?

- Open PayClock and select the Terminal Manager tab on the ribbon bar. The Terminal Manager window will open.
- Select the desired terminal from the list and click Update/Poll Schedule tab.
- Select the “Enable Auto-Poll for this terminal” option.

To poll every X minutes:

- Select the “Poll Clock every...” option.
- From the list choose to poll the clock every 1, 2, 3, 4, 5, 10, 15, 30, 45 or 60 minutes.
- Set the time to begin the polling for the selected day(s). The default is 8:00am.
- Set the time to end the polling for the selected day(s). The default is 8:00pm.
- Select the days of the week to have the auto-poll active. The default is Monday through Friday.
- Select whether to use the host or terminal settings if a conflict is detected.
- Click Save to keep your changes.
- The automatic polling will activate on the desired day(s) at the minutes selected.

To poll at specific times:

- Select the “Poll Clock at these specific times” option.
- Set the first time the poll is to happen and click the Add button.

- During the face recognition process, the terminal will provide guidance for the employee, such as: “Please Get Closer”, “Please Get Farther” or “Adjust Your Action”.
- Upon successful verification the terminal will play a confirmation sound and the screen will display the employee’s first name and time of the punch.

Punching IN/Out - Card & Face Verification (FR700 only)

- Move the badge over the badge reader symbol on the front of the FaceIN.



- When the badge is in close proximity to the FaceIN a confirmation beep will sound.
- The employee should step towards the terminal and stop when within 9 - 25 inches; the terminal will detect the employee and start the face recognition automatically.
- With the face detected, the screen will display a green radar screen rotating clockwise over the employee’s image. A message will display at the bottom of the screen guiding the employee.
- When the employee’s face is in the correct position a green lined frame will display on the screen. The green bar will scan the employee’s image from top to bottom.
- During the face recognition process the terminal will provide guidance for the employee such as: “Please Get Closer”, “Please Get Farther” or “Adjust Your Action”.
- Upon successful verification the terminal will play a confirmation sound and the screen will display the employee’s first name and time of the punch.

Punching IN/Out - Card Verification

(FR700 only)

The Card Verification method only requires that the employee present their badge and then the terminal will take a snapshot of the person presenting the badge. No facial verification occurs.

- Move the badge over the badge reader symbol on the front of the FaceIN.



- When the badge is in close proximity to the FaceIN a confirmation beep will sound and prompt the employee to take a photo.
- The employee should step towards the terminal; a snapshot will be taken of the person presenting the badge.
- The terminal will play a confirmation sound and the screen will display the employee's first name and time of the punch.

Polling the FaceIN Terminal

The PayClock software is used to manage the FaceIN terminal(s) which includes polling and updating the terminal(s). This is done from the Terminal Manager tab within the PayClock software.

Important Note: If you don't have an Ethernet connection, you can transfer punch data from the terminal to the PayClock software using a standard USB thumb drive. See **Appendix B - Exporting Punches using a USB Thumb Drive**.

Polling the FaceIN Terminal

The Poll button group is used to poll or retrieve data from a single terminal or all terminals. When a terminal is polled, punch data will be added to the database allowing you to edit, export and report on the data.

How do I poll a terminal?

- Open PayClock and select the Terminal Manager tab on the ribbon bar. The Terminal Manager window will open.
- Select the desired terminal from the list and click Poll Selected Terminal.
- The punch data residing in the terminal will be added to the database and will be available in the timecard.

How do I poll all terminals?

- Open PayClock and select the Terminal Manager tab on the ribbon bar. The Terminal Manager window will open.
- Click the Poll All Terminals button.
- The punch data residing in all of the terminals will be added to the database and will be available in the timecard.