

PCPROX

User's Guide

**THIS EQUIPMENT COMPLIES WITH FCC REQUIREMENTS
PURSUANT OF PART-15**

This device complies with Part 15 of the FCC Rules. Operation is subject to the following two conditions: (1) this device may not cause harmful interference, and (2) this device must accept any interference received, including interference that may cause undesired operation.

WARNING: Changes or modifications to this product not expressly approved by the party responsible for compliance could void the user's authority to operate this equipment.

Lathem Time Corporation
210 The Bluffs, Suite 107
Austell, GA 30168

www.lathem.com

Copyright © 2020 Lathem Time Corporation. All rights reserved.

Revised 10-19-2020

Document number: USG0123

Contents

Package Contents	1
Install the PCPROX Clock	2
PayClock Online	4
Adding a PCPROX clock	4
Step 1 - Adding a PCPROX Clock	4
Step 2 - Connect the PCPROX to PayClock Online	4
Using the PCPROX	6
Employee Transactions	6
Clocking IN/Out - Badge	6
Clocking IN/Out - PIN	6
Department Transfers - Badge	6
Department Transfers - PIN	6
Amount Entries - Badge	6
Amount Entries - PIN	7
Viewing Totals - Badge	7
Viewing Totals - PIN	7
Supervisor Transactions	8
Setting up a Supervisor for the PCPROX	8
Viewing Punches	8
Adding Punches	8
Viewing Totals	8
Override Lockout	9
Administrator Functions	10
Wireless & Network Setup	10
Sync Now	10
Date/Time Setup	11
Signal-Door Access	11
Device Info	11
Support – Test Connection – Event Log	11
Check for Updates	12
⚠ Restore Factory Defaults	12
Troubleshooting the PCPROX	13
General Troubleshooting	13
Appendix A – Testing the Connection to PayClock Online	14
Appendix B – Installing a Battery	15
Appendix C – Bell Relay Connections	16
Appendix D – Access Relay Connections	19
Appendix E – Add/Edit/Delete Bell Events	21

Package Contents

Please verify that your package includes the following items. If your package is missing an item, please call our help desk at (404) 691-1064.

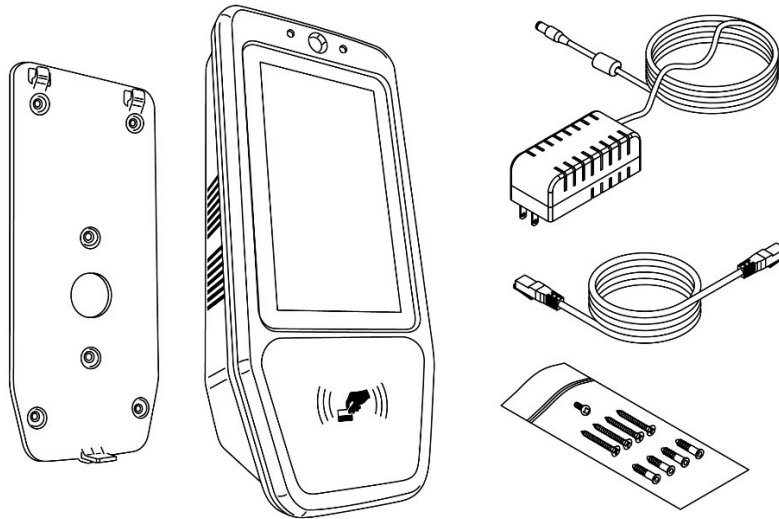

Note: Remove the protective film after the clock is installed.

Recommended Installation Tools



Tape Measure



Pencil



**Philips Head
Screw Driver**



**Optional - Power
Drill & Drill Bits**

Online and Email Support

Lathem.com provides access to numerous support resources. Visit the following link: <http://kb.lathem.com> for additional help or to submit a question. You should receive a reply within 24 hours.

Telephone Support

The help desk is available between the hours of 8am and 6pm ET Monday through Friday. Please call (404) 691-1064 to speak with our help desk.

Install the PCPROX Clock

Step 1: Select a site to install your clock that will be convenient to employees clocking in and out. When deciding where the clock will be installed, keep in mind that an 115vAC power outlet should be within reach of the mounting location as well as either a wired or wireless internet connection.

Step 2: After selecting the appropriate installation site, use the mounting-plate to determine the appropriate height. Hold the mounting-plate on the wall and mark the screw hole locations on the wall.

Install the mounting-plate to the wall using the supplied screws. For sheetrock walls, drill a 3/16" diameter hole through each of the four screw locations: each approx. 1-1/2" deep. Install the plastic "anchors" included in the mounting screw packet.

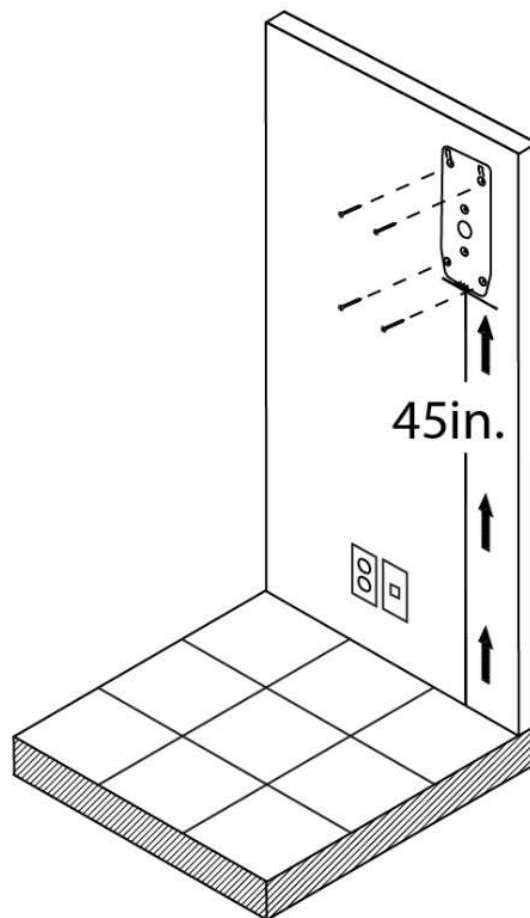

Note: The bottom of the clock should be about **45** inches from the floor.

If using a wired network connection plug the RJ 45 network cable into the Ethernet port and the Power Adapter plug into the power adapter port which is in the compartment on the back of the clock.

Important Note: If using POE (Power Over Ethernet) do not connect power adapter. The existing network must be set up for POE. Please verify with your I.T. department.

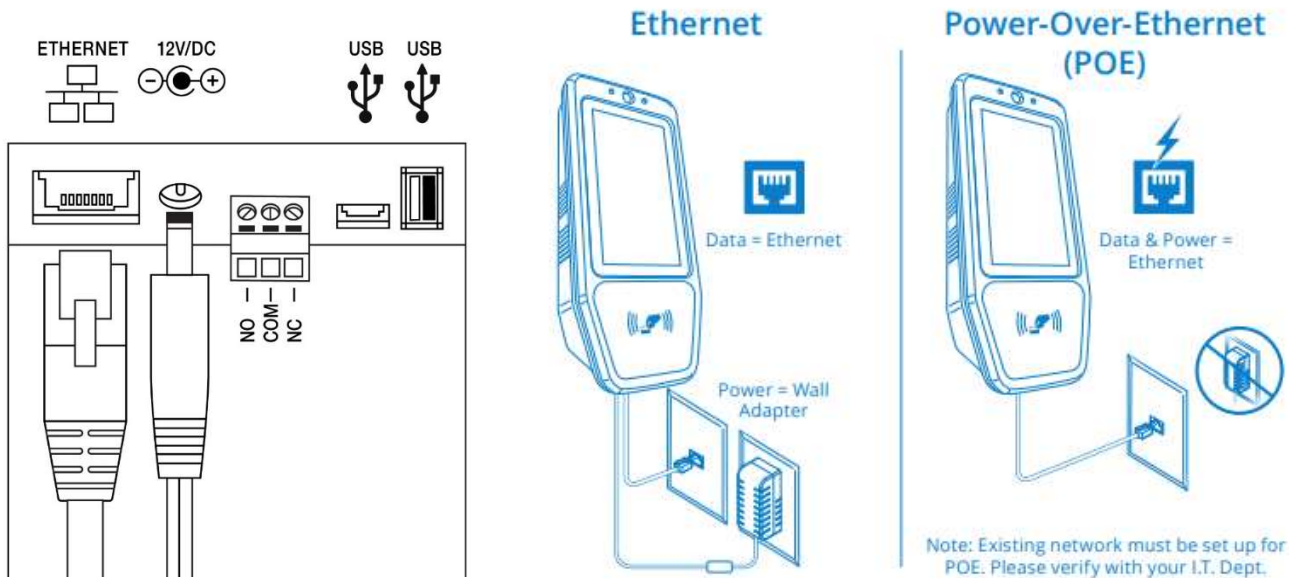

Step 3: Align the PCPROX clock with the tabs on the mounting-plate and secure the two together with the 1 Philips head screw. **Important Note:** Be careful not to pinch the AC cord or network cable.

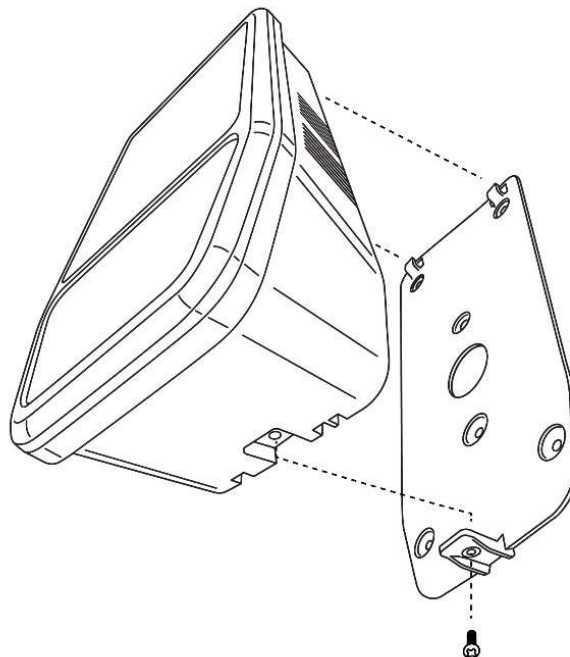

When finished, plug the power adapter into an AC wall outlet.

PayClock Online

The PayClock Online product communicates with the PCPROX over the internet. First set the clock up in PayClock Online and then set up the clock for internet communications.

Adding a PCPROX clock

Adding a PCPROX clock to PayClock Online is a 2-step process. Add the clock in PayClock Online first and then from the clock connect to PayClock Online over the internet.

Step 1 - Adding a PCPROX Clock

The PCPROX clock **must** be added to PayClock Online first otherwise the connection will fail.

- Log into PayClock Online and select Clocks from the list of items on the left.
- Click New. The Select Clock Type window will open.
- Choose PCPROX and click Select. The clock properties will display.
- From the General tab, enter a name for the clock under Device Nickname.
- Next enter the serial number of the clock. **Note:** Enter the serial number **exactly** as it shows on the label on the clock.
- Click Save.

Step 2 - Connect the PCPROX to PayClock Online

The clock must be set up in PayClock Online before attempting this step. The clock must be powered up and connected to the network with access to the internet.

- When the PCPROX is powered up the Hello screen will show, tap Continue.
- Select the connection type, either Wireless or Ethernet and complete the connection set up.
 - Go to Step 2 A for the Wireless connection set up.
 - Go to Step 2 B for the Ethernet connection set up.
- After the connection is set up, tap the ← back arrow, the Connection Test will start, tap Continue.
- The PCPROX will automatically check and install any software updates. **Note:** If multiple updates are needed the startup process may be repeated.
- When the updates have completed the PCPROX will go to the Home screen.
- At the Home screen tap the Settings  button and then enter the Administrator PIN.
- The Settings Menu will open, tap **Sync Now**.
- The clock will connect over the internet to PayClock Online, settings and employees will be downloaded.
- The PCPROX is now ready to be used.

Step 2 A - Wireless Connection

Note: A wireless access point on the network is required.

- Tap Wireless and select Wi-Fi **On** if it isn't already.
- A list of available wireless networks will display.
- Select the desired wireless network, the WIFI Passcode screen will display.
- From the keypad enter the passcode for the wireless network. **Note:** You may need to contact your network administrator for wireless passcode information.
- Tap Connect, when the clock has established the connection it will show Connected under the wireless network name.
- Tap the ← back arrow to continue the setup of the PCPROX.

Step 2 B - Ethernet Connection

Caution: If you are using POE (power over ethernet) do not use the AC power adapter.

- Plug the RJ45 network cable in the Ethernet port.
- Plug the Power Adapter into the Power Adapter port. See drawing below. **Caution:** If you are using POE (power over ethernet) do not use the AC power adapter

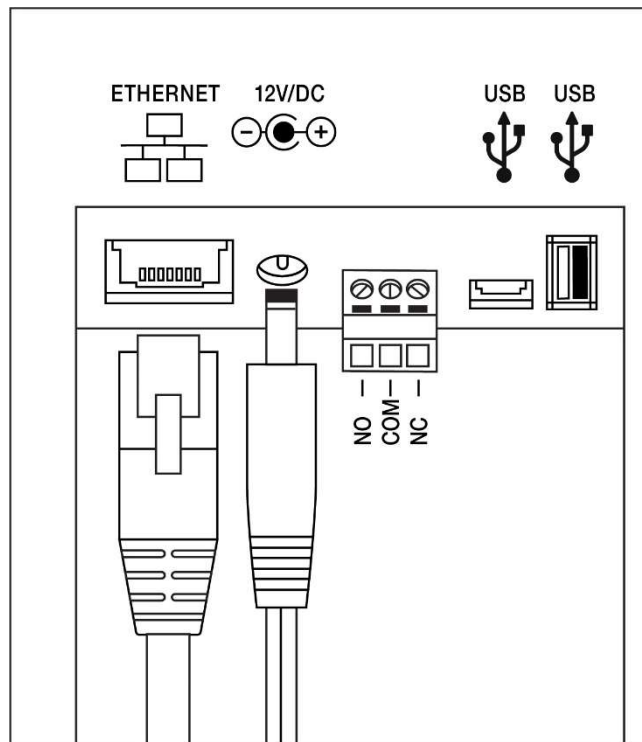

- Tap Ethernet and select Ethernet **On** if it isn't already.
- Tap the ← back arrow to continue the setup of the PCPROX.

Using the PCPROX

The clock will be ready to use after downloading the employees. To punch, the employee will simply present a badge or use a PIN. Instantly they are identified and punched In or Out.

To punch with a badge simply move the badge over the illuminated hand/badge symbol on the on the front of the clock.

When the transaction is successful; a confirmation beep will sound, a text message will appear, a custom audio message may be played, and the display will turn either green or red indicating a good or bad transaction.

Employee Transactions

Employees can record transactions or view totals information by presenting a badge or entering a PIN.

Clocking IN/Out - Badge

- Move the badge over the badge reader symbol on the front of the clock.
- When the badge is read a confirmation beep will sound, a text message will appear, a custom audio message may be played, and the display will turn either green or red indicating a good or bad transaction.

Clocking IN/Out - PIN

- Tap the **Clock In/Out** button on the Home screen of the clock.
- The Enter PIN screen will display. Enter the employee's PIN number and tap .
- A confirmation beep will sound, a text message will appear, a custom audio message may be played, and the screen will turn either green or red indicating a good or bad transaction.

Department Transfers - Badge

- Tap the **Transfer** button on the Home screen of the clock.
- Move the badge over the badge reader symbol on the front of the clock.
- When the badge is read a confirmation beep will sound, and the list of available departments will display.
- Tap the desired department. A confirmation screen will display showing the department into which the employee transferred.



Department Transfers - PIN

- Tap the **Transfer** button on the Home screen of the clock.
- The Enter PIN screen will display. Enter the employee's PIN number and tap . A confirmation beep will sound, and the list of available departments will display.
- Tap the desired department. A confirmation screen will display showing the department into which the employee transferred.

Amount Entries - Badge

- Tap the **Amounts** button on the Home screen of the clock.
- Move the badge over the badge reader symbol on the front of the clock.
- When the badge is read a confirmation beep will sound and the AMOUNT ENTRY screen will display.
- Using the numeric keypad enter the value for the amount and tap . A confirmation screen will display showing the amount entered for the employee.

Amount Entries - PIN

- Tap the **Amounts** button on the Home screen of the clock.
- The Enter PIN screen will display. Enter the employee's PIN number and tap .
- A confirmation beep will sound, and the AMOUNT ENTRY screen will display.
- Using the numeric keypad enter the value for the amount and tap . A confirmation screen will display showing the amount entered for the employee.

Viewing Totals - Badge

- Tap the **Totals** button on the Home screen of the clock.
- Move the badge over the badge reader symbol on the front of the clock.
- When the badge is read, a confirmation beep will sound, and the employee's grand totals for the pay period and any benefit time will display.

Viewing Totals - PIN

- Tap the **Totals** button on the Home screen of the clock.
- The Enter PIN screen will display. Enter the employee's PIN number and tap .
- A confirmation beep will sound and the employee's grand totals for the pay period and any benefit time will display.

Supervisor Transactions

Supervisors have the ability at the clock to view and edit employee punches, add new employees, and override shift lockouts.

Setting up a Supervisor for the PCPROX

To set up an employee as a supervisor, in PayClock Online go to Employees and select the desired employee. Set the employee's Access Profile to "Supervisor", then set the Manage Other Employees option to Allow. Click Assign Employees and select the employees they will be able to manage at the PCPROX.

To enter supervisor mode at the clock, tap the supervisor  button. The Enter PIN screen will display. Use one of the following methods to enter Supervisor Mode:

- Using the numeric keypad enter the supervisors PIN and tap .
- Move the supervisor's badge over the badge reader symbol on the front of the clock.



Viewing Punches

At the clock tap the supervisor  button. The Enter PIN screen will display.

- Using either a badge or PIN, enter supervisor mode.
- At the Employee selection screen, tap on the name of the desired employee.
- Tap Punches. The Punches screen will display.
- Use the left and right arrows to scroll through the punch information.
- When finished tap  to return to the Home screen.

Adding Punches

Tap the supervisor  button on the clock. The Enter PIN screen will display.

- Using either a badge or PIN, enter supervisor mode.
- At the Employee selection screen, tap on the name of the desired employee.
- Tap Punches. The Punches screen will display.
- Use the left and right arrows to select the desired date and press the  button.
- Using the clock face, select the desired hour and minutes for the punch and then tap **OK**.
- At the confirmation screen select Yes to add the punch. The added punch will display on the screen and will be added to the employee's timecard.
- When finished tap  to return to the Home screen.

Viewing Totals

Tap the supervisor  button on the clock. The Enter PIN screen will display.

- Using either a badge or PIN, enter supervisor mode.
- At the Employee selection screen, tap on the name of the desired employee.
- Tap Totals. The employee's totals for the pay period and any benefit time will display.
- When finished tap  to return to the Home screen.



Override Lockout

Tap the supervisor  button on the clock. The Enter PIN screen will display.

- Using either a badge or PIN, enter supervisor mode.
- At the Employee selection screen, tap on the name of the desired employee.
- Tap Override Lockout.
- At the confirmation screen select Yes to have the next punch for the employee ignore the shift lockout.
- When finished tap  to return to the Home screen.

Administrator Functions



The PCPROX has one administrator. The Settings  button allows you to review the device information, set up the network communications, set the time format & DST, test the connection to the internet and PayClock Online, review an event log, and reset the clock to factory defaults.

To enter the settings menu, at the clock tap the Settings  button, enter the administrator PIN and tap .

- The Settings Menu will display.

Wireless & Network Setup

This menu allows you to configure the network communication settings between the PCPROX and PayClock Online.

At the clock tap the Settings  button, enter the administrator PIN and tap .

- The Settings Menu will display.
- Tap Wireless & Network. The Wireless & Network Setup screen will display.

Wireless

Note: A wireless access point on the network is required.

- From the Settings Menu tap Wireless & Network. The Wireless & Network Setup screen will display.
- Tap Wireless and select Wi-Fi **On** if it isn't already.
- A list of available wireless networks will display.
- Select the desired wireless network, the WIFI Passcode screen will display.
- From the keypad enter the passcode for the wireless network. **Note:** You may need to contact your network administrator for wireless passcode information.
- Tap Connect, when the clock has established the connection it will show Connected under the wireless network name.
- When finished tap  to return to the Home screen.



Ethernet

Caution: If you are using POE (power over ethernet) do not use the AC power adapter.

- Plug the RJ45 network cable in the Ethernet port.
- Plug the Power Adapter into the Power Adapter port. **Caution:** If you are using POE (power over ethernet) do not use the AC power adapter
- Tap Ethernet and select Ethernet **On** if it isn't already.
- When finished tap  to return to the Home screen.

Sync Now



This menu allows you to initiate a manual synchronization between PayClock Online and the clock.

At the clock tap the Settings  button, enter the administrator PIN and tap .

- The Settings Menu will display.
- Tap Sync Now, the clock will start the update process and return the Home screen when finished.

Date/Time Setup



This menu allows you to manually configure the time zone, DST and how the hours will display on the clock.

At the clock tap the Settings  button, enter the administrator PIN and tap .

- The Settings Menu will display.
- Tap Date & Time and make the desired changes.
- When finished tap  to return to the Home screen.

Signal-Door Access

This menu allows you to configure how the clock uses the on-board relay.



At the clock tap the Settings  button, enter the administrator PIN and tap .

- The Settings menu will display.
- Tap Signal-Door Access. The signal-door access screen will display.
- Select the Relay Mode.
 - Off – The relay is disabled.
 - Access – The relay will be used to activate a door strike allowing employees to enter the facility.
 - Signal – The relay will open/close to sound the signaling device.
- If Signal is selected the Add / Edit Events will show. Tap Add / Edit Events and enter the bell events. Up to 100 events can be programmed.
- Select the duration to for the relay. By default, it is set at 5 seconds.
- Use the Test button to activate the on-board relay to test the connection.
- When finished tap  to return to the Home screen.

See **Appendix E** for steps to add/edit/delete bell events.

Device Info

This menu item displays clock information such as the clocks serial number and software version.



At the clock tap the Settings  button, enter the administrator PIN and tap .

- The Settings menu will display.
- Tap Device Info. The device information will display.
- When finished tap  to return to the Home screen.

Support – Test Connection – Event Log

This menu item allows you to test the clocks connection to the internet and PayClock Online. You can also display any errors that the clock may have experienced.



Testing the Clocks Internet Connection

At the clock tap the Settings  button, enter the administrator PIN and tap .

- The Settings menu will display.
- Tap Support and then Test Connection.
- The internet connection, ports, and connection to PayClock Online will be tested.
- When finished tap  to return to the Home screen.

See **Appendix A** for details on testing the clocks connection.



Reviewing the Clocks Event Log

At the clock tap the Settings  button, enter the administrator PIN and tap .

- The Settings menu will display.
- Tap Support and then Error Log.
- Any logged information will display.
- When finished tap  to return to the Home screen.

Check for Updates

This menu item allows the clock to check to see if any updates are available. If updates are found the clock will guide the user through the update process.

At the clock tap the Settings  button, enter the administrator PIN and tap .



- The Settings menu will display.
- Tap Check for Updates. Please be patient this may take a few minutes. Follow the on-screen instructions.
- When finished tap  to return to the Home screen.

Restore Factory Defaults

Use caution when selecting this menu item. This menu item will reset the entire clock to the manufacturer default settings.

All settings, administrators, supervisors, employees, and data will be cleared from the clock; you cannot recover this information.

Important Note: The Administrator PIN, network settings and relay schedules will remain and will not be reset.

At the clock tap the Settings  button, enter the administrator PIN and tap .

- The Settings menu will display.
- Tap **Restore Factory Defaults**. The warning screen will display.
- At the warning screen tap **RESTORE FACTORY DEFAULTS** if you wish to continue.
- The clock will be reset and will be as if it were a new clock that has never been used and will need to be set up.

Troubleshooting the PCPROX



If the PayClock software does not communicate with the clock, try these suggestions:

General Troubleshooting

- Make sure that all connections are secure, and the cable is intact, or the wireless access point is connected.
- Make sure that the network cable is securely connected to the Ethernet port on the clock.
- Make sure the wireless access point is working.
- Make sure that the clock's power supply is securely connected to an electrical outlet.
- Make sure that the power supply is securely connected to the clock and the unit is powered up.

If after going through each item above you are still not communicating with the clock, have your network administrator or IT person make sure there are not any issues with the network.



PCPROX Troubleshooting

Issue	Resolution
The clock isn't connecting to PayClock Online.	If your clock is not connecting to PayClock Online, use the Test Connection button. See Appendix A for details.
The clock shows "Not Found" when a badge is presented.	Make sure that the number that is printed on the badge matches what was entered in the Badge Number field in PayClock for the employee.
What does the cloud  on the display represent?	This represents that the clock is connected to PayClock Online.
What does the bar graph  on the display represent?	This represents the signal strength for the wireless connection.
Why does the clock show "Punch Accepted" instead of Punch In or Out when an employee punches?	The clock lost the connection to the internet, so it displays Punch Accepted. The clock must have a connection to the internet to determine if a punch is In or Out. Check to see if the cloud  icon is displaying at the top of the screen.
Why do the employee badges sometimes register a punch while in the badge rack?	The clock uses an internal antenna. Make sure badges are kept 6" away from the clock when not in use to avoid accidental badge reads.

Appendix A – Testing the Connection to PayClock Online

Important - This tool has been designed to help in the event the clock fails to connect to PayClock Online. It may be necessary to involve your IT department or someone familiar with your network if you have connection issues.

The PCPROX clock has a function that will allow the user to test the connection to PayClock Online.

Tap the Settings  button, enter the administrator PIN and tap .

- The Settings menu will display.
- Tap **Support** and then **Test Connection**.

Test 1 - Internet connection test.

Pass = The test cycle will move to the port test.

Fail – What should I do if this test fails?

- Does another device successfully connect to the internet? Such as a laptop(wired/wifi) or a smartphone(wifi).
- Contact your IT department for assistance.

Test 2 – Ports used by the clock will be tested.

Pass = The test cycle will move to the PayClock Online service test.

Fail – What should I do if this test fails?

- Open the listed port(s) to traffic.
- Contact your IT department to open the listed port(s) to traffic.

Test 3 – PayClock Online Service used by the clock will be tested.

Pass = The test cycle will display a summary of the test.

Fail – What should I do if this test fails?

- Open the listed port(s) to Inbound / Outbound traffic.
- Contact your IT department to open the listed port(s) to traffic.

Test 4 – Is the PCPROX clock set up in PayClock Online.

Pass = The test cycle will display a summary of the test.

Fail – What should I do if this test fails?

- Open PayClock Online and set up the PCPROX under Clocks.

Notes - The internet test will attempt to ping www.google.com. If ping is disabled on the network a false test result could be displayed and may require you to involve your IT department or someone familiar with your network.

It may be necessary to involve your IT department or someone familiar with your network if there is a failure with the Ports or PayClock Online Services test which requires changes to the network / firewall settings.

Appendix B – Installing a Battery

The PCPROX has an optional re-chargeable battery, so the clock is operational during a power failure. Once the power is restored the battery will automatically re-charge.

- Remove the cover from the battery compartment on the back of the clock.
- Position the battery connector as shown.
- Plug the battery connector into the clock connector.
- Tuck the connector wires and battery into the battery compartment, being careful not to pinch the wires.
- Insert the cover into the slot and snap it into place.

Note: Make sure the wires are not pinched when closing cover.

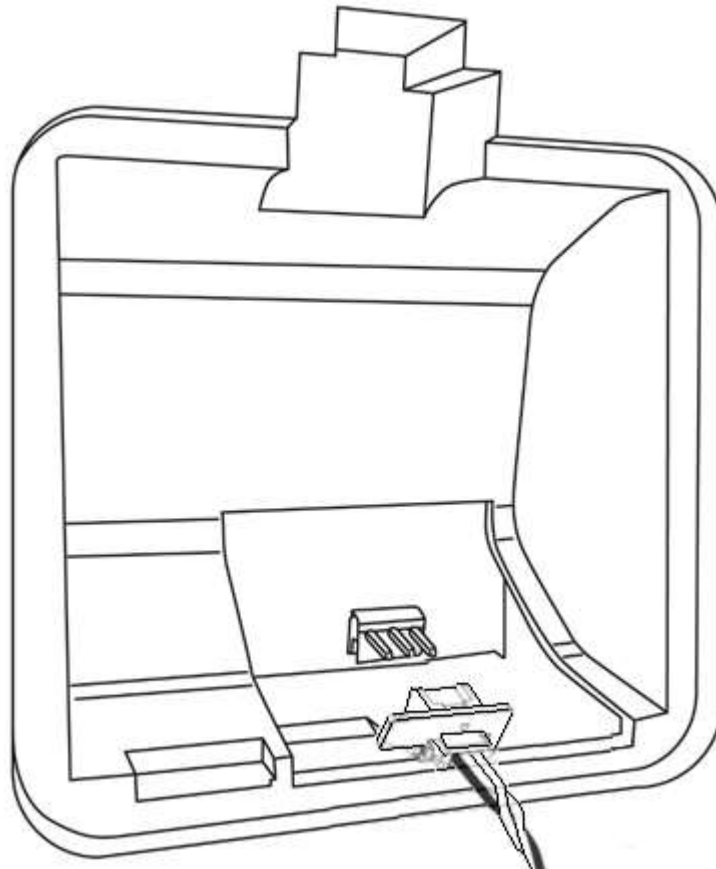

Appendix C – Bell Relay Connections

The PCPROX has a built-in relay that can control bells or door access.

Relay Specifications

- Type: Dry Contact Closure
- Rating: 2 amps at 24VDC or 120VAC
- Contacts: NO-Normally Open, COM-Common, NC-Normally Closed

Bell Relay Connections

When you are connecting to a signaling device make sure you have the following skills:

- Understand basic wiring principles and techniques
- Can interpret wiring diagrams
- Have circuit wiring experience

Note: The wiring must be installed in accordance with national and local electrical codes.

To connect the signaling device

- Unplug the relay screw terminal connector on the back of the clock.

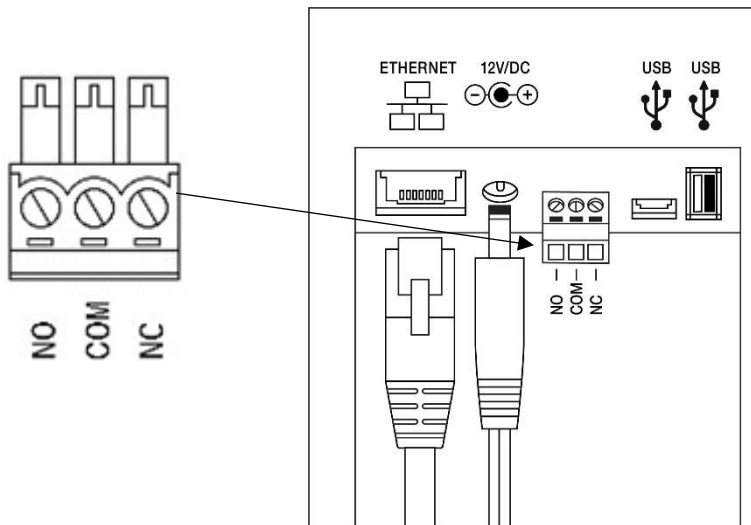

- Connect the wires from the signaling device to the screw terminals. Plug the terminal connector into the socket on the clock. Only one (1) wire should be inserted into the terminal block positions NO and COM, all wire splices should be done externally. See the following diagrams for details.

Important! Relay contacts provide no power for signaling devices. The relay is a dry contact closure rated 2 amps at 24VDC or 120 VAC. Connecting a device or series of devices that draw more than the rated amperage from the terminal will result in serious damage! It is recommended to use the optional SR501-4 Relay Booster Box to control devices that require more than 2 amps.

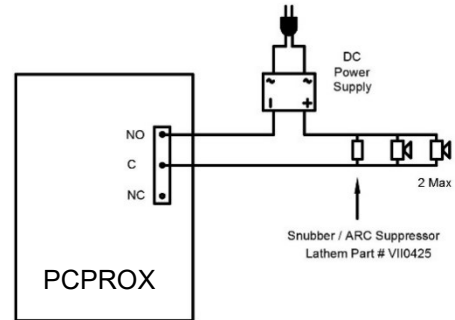
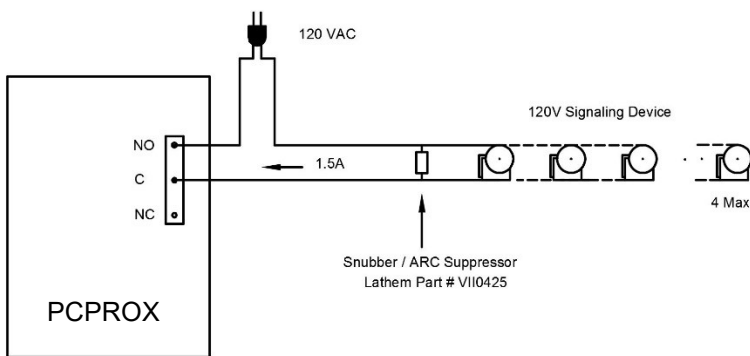
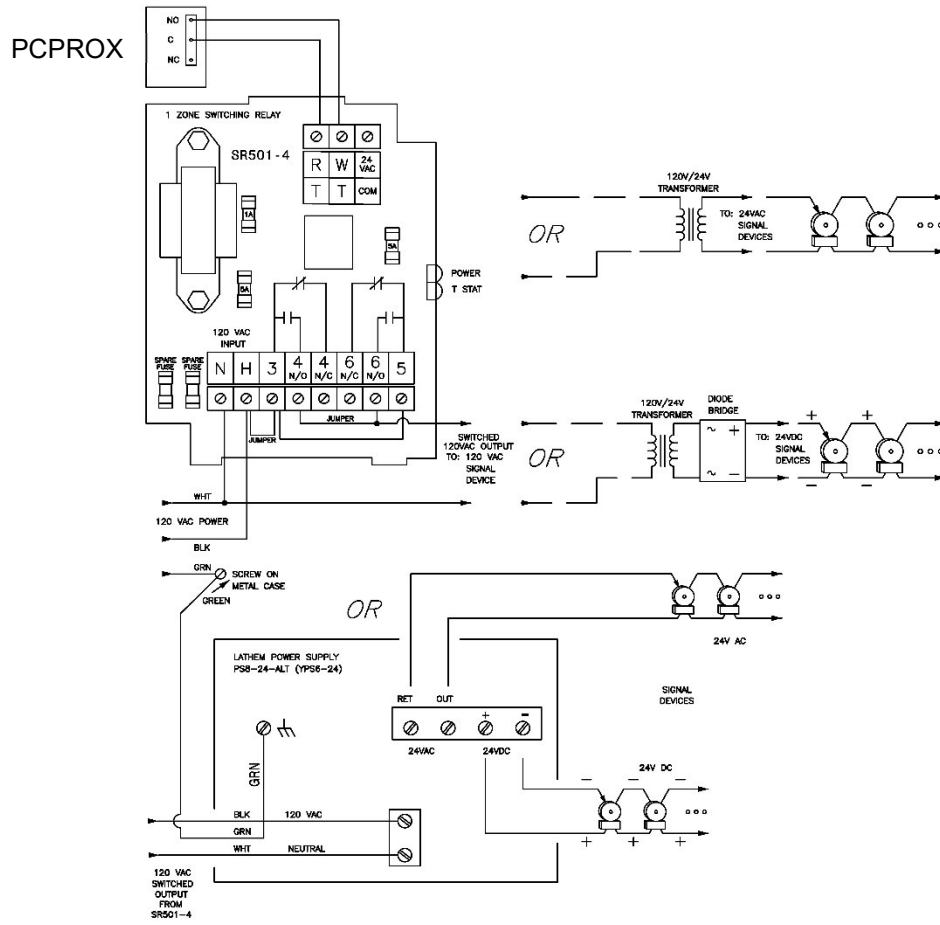

Wiring to P.A. System / Tone Generator

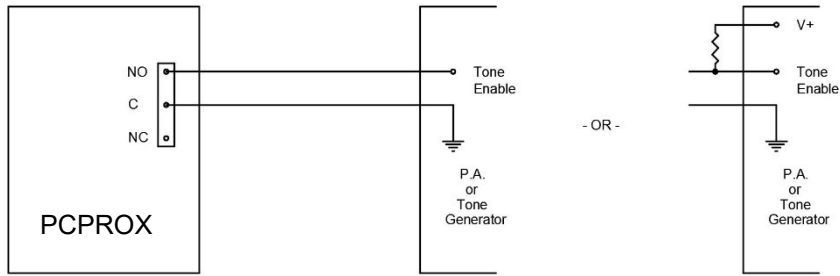

- OR -

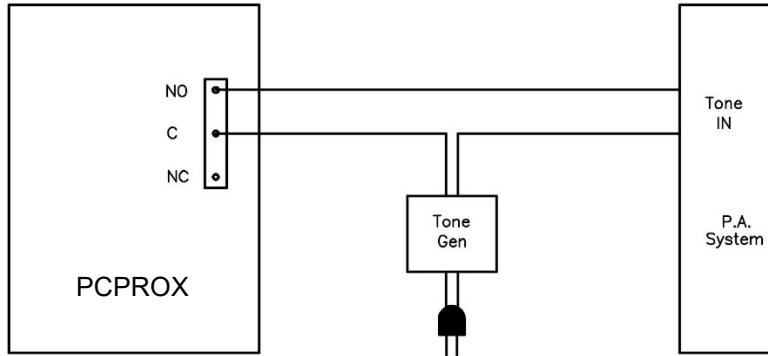

Important! Connecting the PCPROX to a public address (PA) system requires the use of an external Tone Generator. Contact your PA supplier to acquire an appropriate Tone Generator for your system.

Appendix D – Access Relay Connections

When you are connecting to a door access device make sure you have the following skills:

- Understand basic wiring principles and techniques
- Can interpret wiring diagrams
- Have circuit wiring experience

Note: The wiring must be installed in accordance with national and local electrical codes.

Connecting the PCPROX to a Door Strike

- Unplug the relay screw terminal connector on the back of the clock.

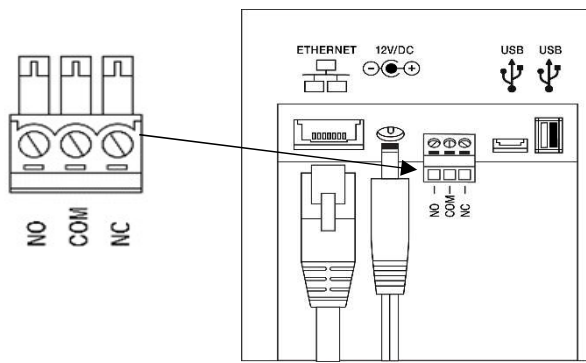

- Connect the wires from the door access device to the screw terminals. Plug the terminal connector into the socket on the PCPROX. Only one (1) wire should be inserted into the terminal block positions NO and COM, all wire splices should be done externally. See the following diagrams for details.

Important! Relay contacts provide no power for signaling devices. The relay is a dry contact closure rated 2 amps at 24VDC or 120 VAC. Connecting a device or series of devices that draw more than the rated amperage from the terminal will result in serious damage! It is recommended to use the optional SR501-4 Relay Booster Box to control devices that require more than 2 amps.

Wiring for a Door Access Control System

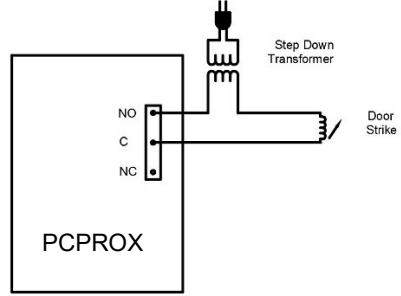
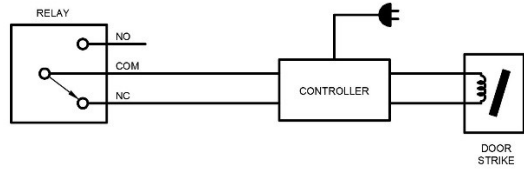

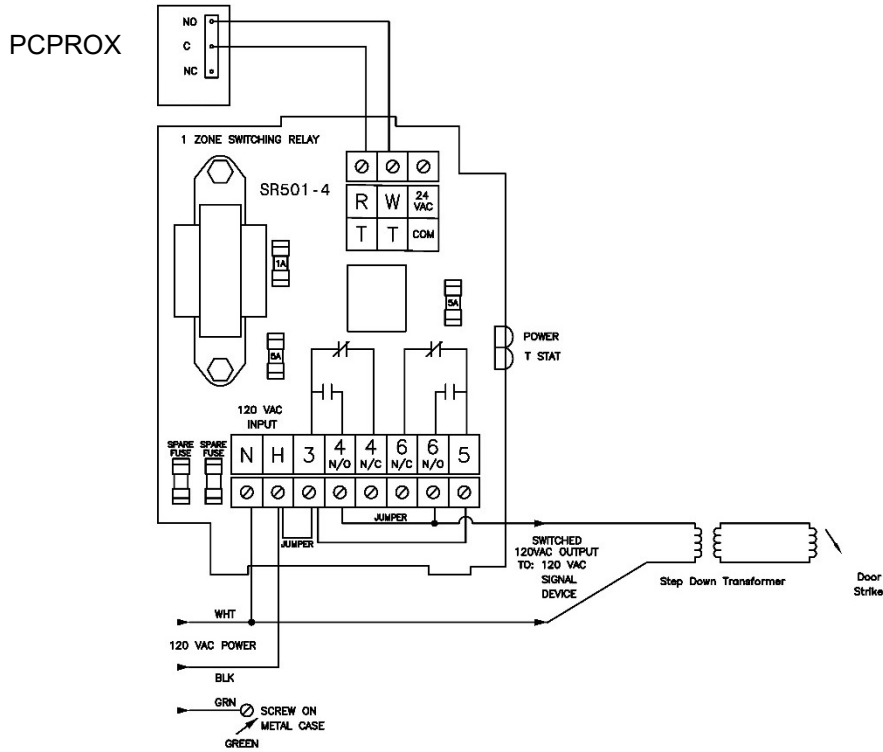

Door Strike Wiring For Door Strikes more than 1.5 Amps (Peak)





Appendix E – Add/Edit/Delete Bell Events



Up to 100 events can be programmed. Events consist of the time and the day of week.

Adding a Bell Event





At the clock tap the Settings  button, enter the administrator PIN and tap .

- The Settings Menu will display.
- From the Settings menu tap Signal-Door Access.
- The Relay Settings screen will display.
- Under Relay Mode select Signal.
- Under Schedule tap Add/Edit Events. The Relay Schedule screen will display.
- Tap , the time selection screen will display.
- Set the desired hour, minute, and AM/PM for the relay event.
- Tap OK to save the event. The programmed event will display in the list.
- Tap on the desired days of the week and then continue adding events. Note: Changes to the days of the week are automatically saved.
- When finished tap  to return to the Home screen.

Editing a Bell Event

- At the clock tap the Settings  button, enter the administrator PIN and tap .
- From the Settings menu tap Signal-Door Access.
- The Relay Settings screen will display.
- Under Schedule tap Add/Edit Events. The Relay Schedule screen will display with the scheduled events.
- Tap on the desired event and make the needed changes.
- Tap OK to save the changes. Note: Changes to the days of the week are automatically saved.
- When finished tap  to return to the Home screen.

Deleting a Bell Event

- At the clock tap the Settings  button, enter the administrator PIN and tap .
- From the Settings menu tap Signal-Door Access.
- The Relay Settings screen will display.
- Under Schedule tap Add/Edit Events. The Relay Schedule screen will display with the scheduled events.
- Tap on the down arrow on the desired event. Tap the  and the scheduled event will be deleted.
- When finished tap  to return to the Home screen.

One-Year Limited Warranty

Lathem warrants the hardware products described in this guide against defects in material and workmanship for a period of one year from date of original purchase from Lathem or from an authorized Lathem reseller. The conditions of this warranty and the extent of the responsibility of Lathem Time Corporation ("Lathem") under this warranty are listed below.

1. This warranty will become void when service performed by anyone other than an approved Lathem warranty service dealer results in damage to the product.
 2. This warranty does not apply to any product which has been subject to abuse, neglect, or accident, or which has had the serial number altered or removed, or which has been connected, installed, adjusted, or repaired other than in accordance with instructions furnished by Lathem.
 3. This warranty does not cover dealer labor cost for removing and reinstalling the machine for repair, or any expendable parts that are readily replaced due to normal use.
 4. The sole responsibility of Lathem under this warranty shall be limited to repair of this product, or replacement thereof, at the sole discretion of Lathem.
 5. If it becomes necessary to send the product or any defective part to Lathem or any authorized service dealer, the product must be shipped in its original carton or equivalent, fully insured with shipping charges prepaid. Lathem will not assume any responsibility for any loss or damage incurred in shipping.
 6. **WARRANTY DISCLAIMER AND LIMITATION OF LIABILITY:** Except only the limited express warranty set forth above, the products are sold with no expressed or implied warranties of any kind, and the implied warranties of merchantability and fitness for a particular purpose are hereby expressly disclaimed. No warranties are given with respect to products purchased other than from Lathem or an authorized Lathem reseller and any such products are purchased "as is, with all faults." In no event will Lathem be liable for any direct, indirect, special, incidental or consequential damages arising out of or in connection with the delivery, use or inability to use, or performance of this product. In the event any limited remedy given herein shall be deemed to have failed of its essential purpose, Lathem's maximum liability shall be to refund the purchase price upon return of the product.
 7. Proof of date of purchase from Lathem or an authorized Lathem reseller is required for warranty service on this product.
 8. This Warranty grants specific legal rights. Additional legal rights, which may vary by locale, may also apply.
 9. Should any difficulties arise with the performance of this product during warranty, or with any Lathem authorized service centers, contact Lathem Time.
-